



COAXIAL WEDGE **CW-152**

Exclusive Coaxial Design

Provides true point source performance, with outstanding resolution and tonal clarity.

Two-way active

Controlled by Synco 2004, 3006 or 4008. Will give you a very easy to work with, small, very loud, top level wedge.

True Point Source Performance

The unique Coaxial design of the SYNCO CW152 loudspeaker, ensures proper signal alignment and constant directivity and "Q" through crossover. This enables the CW152 to provide tonal balance and resolution not attainable from any other design.

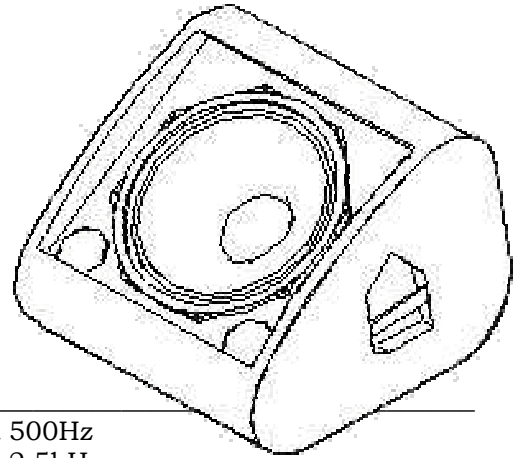
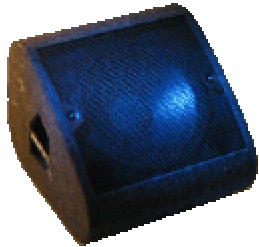

SENSITIVITY:	100dB (1w/1m) @ 500Hz 108dB (1w/1m) @ 2.5kHz
MAXIMUM SPL:	132dB
DISPERSION:	75° H by 75° V
FREQ. RESPONSE:	45Hz to 18kHz
HIGH DRIVER:	CD2-8, 2" drivers, 8Ω; 100W RMS,
LOW DRIVER:	15" Woofer, 6Ω; 600W AES
CROSSOVER POINT:	1.2kHz
ENCLOSURE:	13 ply hardwood, heavily braced
GRILLE:	Perforated metal grille with moisture resistant foam insert
CONNECTOR:	four 4-pin Neutrik
FINISH:	Grey carpet
HARDWARE:	Handles
DIMENSIONS:	16.9"H x 19.9"W x 21.5"D (43.0cm x 50.5cm x 54.5cm)
NET WEIGHT:	83 Lbs. (37.5 Kg)